



RPCE3-*

PILOT OPERATED FLOW CONTROL VALVE WITH ELECTRIC PROPORTIONAL CONTROL

SERIES 52

RPCE3- * two-way
RPCE3-100-T3 three-way

SUBPLATE MOUNTING
ISO 6263-07 (CETOP 07)

p max **250** bar
Q max (see performances table)

OPERATING PRINCIPLE

RPCE3-*

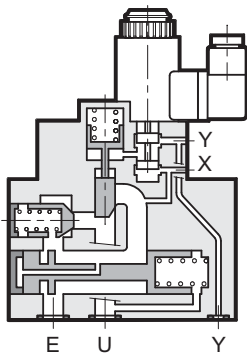

RPCE3-100-T3

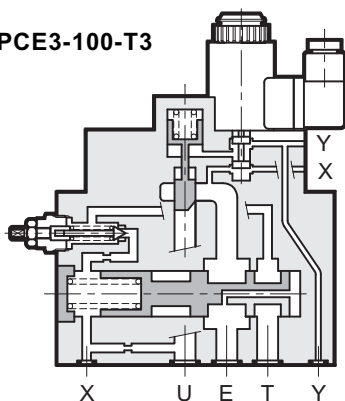

- RPCE3-* valves are two-way or three-way flow control valves with pressure and thermal compensation and electric proportional control with mounting interface in compliance with ISO 6263 (CETOP RP 121H) standards.
- These valves are normally used for flow rate control in hydraulic circuit branches and for speed control of hydraulic actuators.
- Flow rate can be modulated continuously in proportion to the current supplied to the solenoid.
- The valve can be controlled directly by a current control supply unit or by means of the relative electronic control units which enable optimal valve performance (see paragraph 12).
- The valves are available in two flow control ranges of 100 l/min, with progressive gain or with differential gain.
- To ensure correct valve operation, maintain a minimum pilot control flow rate of 2 l/min and minimum pressure of 20 bar.
- Pilot control can be internal, with intake of oil from line E, or external from a line with 1/4" BSP connection on the pilot body.
- Drainage is always external and must be connected directly to the tank without backpressure by means of subplate connection Y (OR Ø32) or by means of a line (1/4" BSP coupling) on the pilot body.
- The three-way version RPCE3-100-T3 allows flow control to the circuit by dumping the exceeding flow to the tank. Maximum pressure in the circuit is limited by means of a manual adjustment relief valve which operates on the compensator pilot.
- RPCE3-100-T3 valve is also available in /M version, which allows, by means of an electric control, to unload the total flow with a minimum pressure drop.

HYDRAULIC SYMBOLS

RPCE3-*

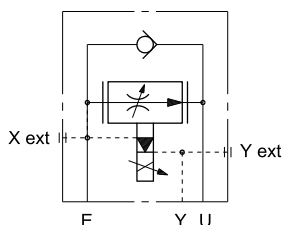

RPCE3-100-T3

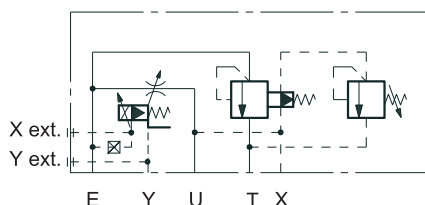

RPCE3-100-T3M

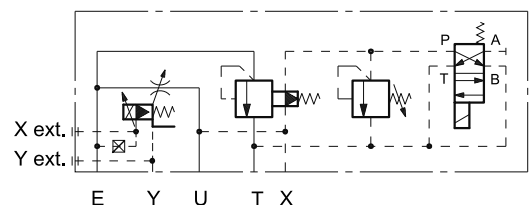



1 - IDENTIFICATION CODES

1.1 - Identification code for two-way valve: RPCE3-*

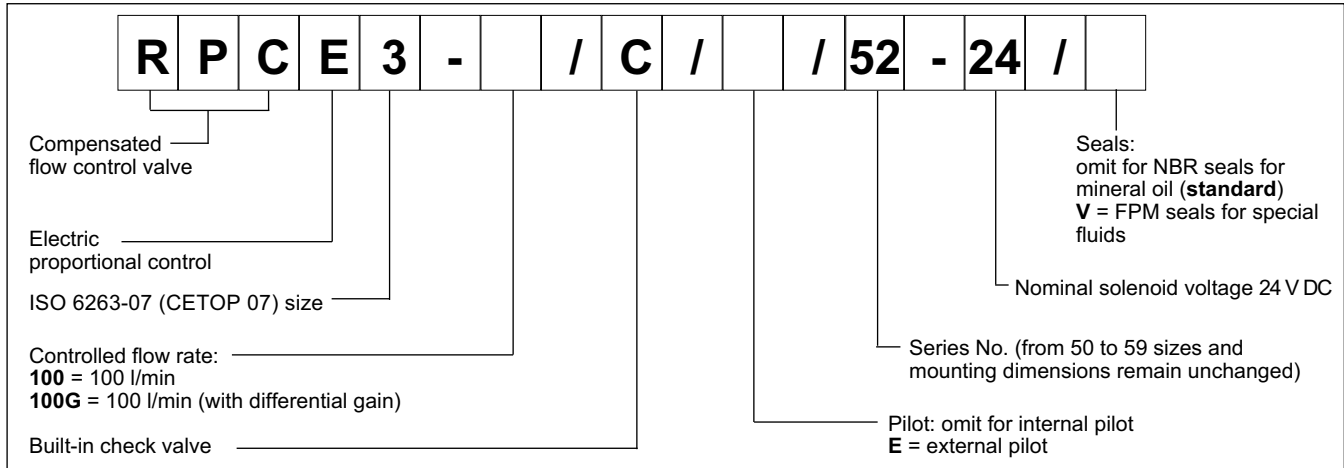

1.2 - Identification code for three-way valve: RPCE3-100-T3

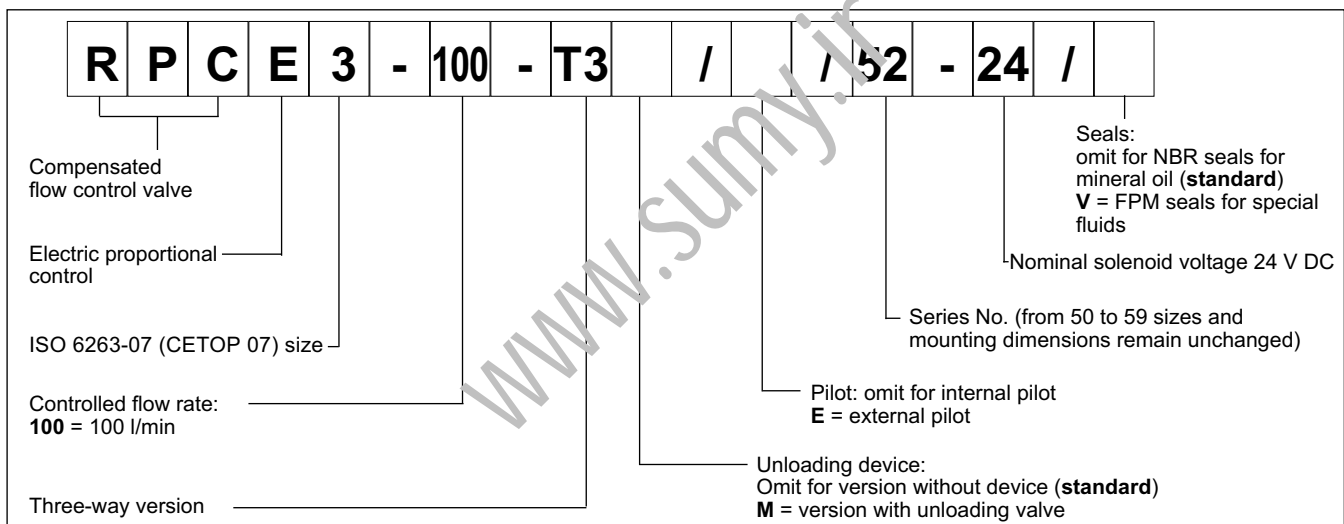

PERFORMANCES (obtained with mineral oil with viscosity of 36 cSt at 50°C and the related electronic control units)

Maximum working pressure		250
Minimum Δp across E and U ports	bar	10
Piloting pressures:		
min		20
max		160 (NOTE 1)
Maximum controlled flow E→U (RPCE3-*)		100
Minimum controlled flow with P=100 bar (version 100)	l/min	1,5
(version 100G)		0,5
Maximum free reverse flow U→E		150 (NOTE 2)
Step response	see paragraph 8	
Hysteresis (with PWM 100 Hz)	% of Q_{max}	< 8%
Repeatability	% of Q_{max}	< ±3%
Electrical features	see paragraph 7	
Ambient temperature range	°C	-10 / +50
Fluid temperature range	°C	-20 / +80
Fluid viscosity range	cSt	10 ÷ 400
Fluid contamination degree	According to ISO 4406:1999 class 18/16/13	
Recommended viscosity	cSt	25
Mass:		
RPCE3-*	RPCE3-100-T3	10,8
	RPCE3-100-T3M	12,6

NOTE 1: Pilot must be external if the valve is used with line pressure over 160 bar.

NOTE 2: Maximum recommended flow U→E through the check valve (only for two-way version)

3 - HYDRAULIC FLUIDS

Use mineral oil-based hydraulic fluids HL or HM type, according to ISO 6743-4. For these fluids, use NBR seals. For fluids HFDR type (phosphate esters) use FPM seals (code V). For the use of other kinds of fluid such as HFA, HFB, HFC, please consult our technical department. Using fluids at temperatures higher than 80 °C causes a faster degradation of the fluid and of the seals characteristics. The fluid must be preserved in its physical and chemical characteristics.

4 - CHARACTERISTIC CURVES (measured with viscosity of 36 cSt at 50°C)

4.1 2-way valve

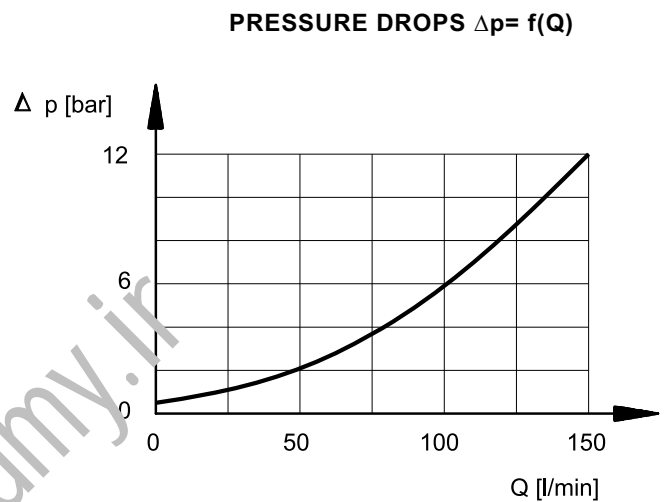
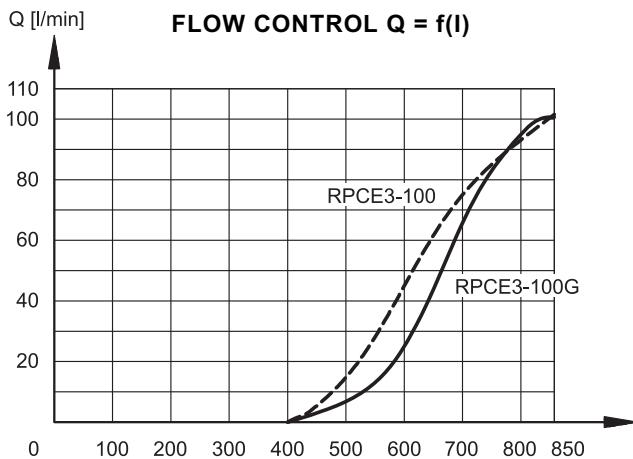

Typical flow control curves for flow rate E→U, according to the current supplied to the solenoid. The RPCE3-100G version, featuring differential gain control, is particularly suitable for "FAST-SLOW" flow rate control as it ensures high sensitivity at low flow rates while enabling high flow rates for rapid actuator movement.

Pressure drops with free flow U→E through the check valve

4.1 3-way valve

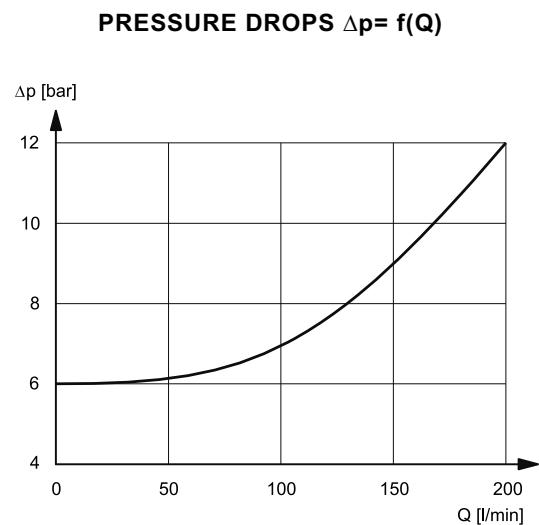
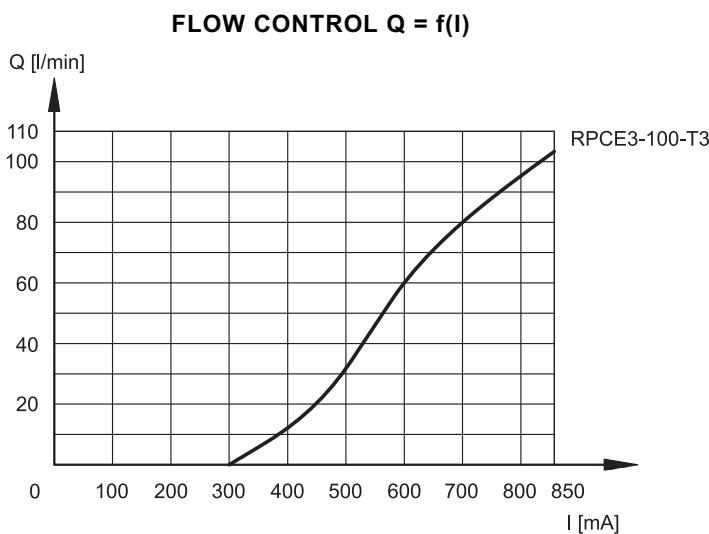

Typical flow control curves for flow rate E→U, according to the current supplied to the solenoid.

Pressure drops E→T (only for three-way versions)
Curve obtained with unloading electrical control (RPCE3-100-T3M)



5 - PRESSURE COMPENSATION

The valves are equipped with two restrictors. The first is an opening which can be adjusted by the proportional solenoid; the second, controlled by the pressure upstream and downstream of the first restrictor ensures constant pressure drop across the adjustable restrictor. In these conditions, the set flow rate value is maintained constant within a tolerance range of $\pm 3\%$ of the set flow rate for maximum pressure variation between the valve inlet and outlet chambers.

6 - THERMAL COMPENSATION

A temperature-sensitive device installed on the flow control element corrects the position and maintains the set flow rate virtually unchanged, also in the case of fluid viscosity variation.

Flow rate variation remains within 2,5% of the set flow rate, for a fluid temperature variation of 10°C.

7 - ELECTRICAL CHARACTERISTICS

Proportional solenoid

The proportional solenoid comprises two parts: tube and coil.

The tube, screwed to the valve body, contains the armature which is designed to maintain friction to a minimum thereby reducing hysteresis.

The coil is mounted on the tube secured by means of a lock nut and can be rotated through 360° depending on installation clearances.

NOMINAL VOLTAGE	V DC	24
RESISTANCE (at 20°C)	Ω	16.6
MAXIMUM CURRENT	A	0.85
ELECTROMAGNETIC COMPATIBILITY (EMC)	According to 2004/108/CE	
CLASS OF PROTECTION: Atmospheric agents (CEI EN 60529)	IP 65	

8 - STEP RESPONSE (with mineral oil with viscosity of 36 cSt at 50°C with the related electronic control units)

Step response is the time taken for the valve to reach 90% of the set pressure value following a step change of reference signal. The table shows typical response times measured with valves "S" (150 l/min) and with an input pressure of 100 bar.

REFERENCE SIGNAL STEP	0 → 100%	100% → 0
Step response [ms]	250	120

9 - INSTALLATION

The RPCE3 valve, both two-way or three-way versions, can be installed in any position without impairing correct operation. Ensure that there is no air in the hydraulic circuit.

Valves are fixed by means of screws or tie rods on a flat surface with planarity and roughness equal to or better than those indicated in the relative symbols. If minimum values are not observed fluid can easily leak between the valve and support surface.

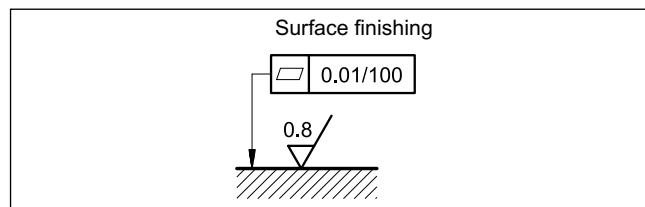

10 - ELECTRONIC CONTROL UNITS

EDC-111	for solenoid 24V DC	plug version	see cat.89 120
EDM-M111	for solenoid 24V DC	DIN EN 50022 rail mounting	see cat. 89 250

11 - OVERALL AND MOUNTING DIMENSIONS THREE-WAY VALVES RPCE3-100-T3 and RPCE3-100-T3M

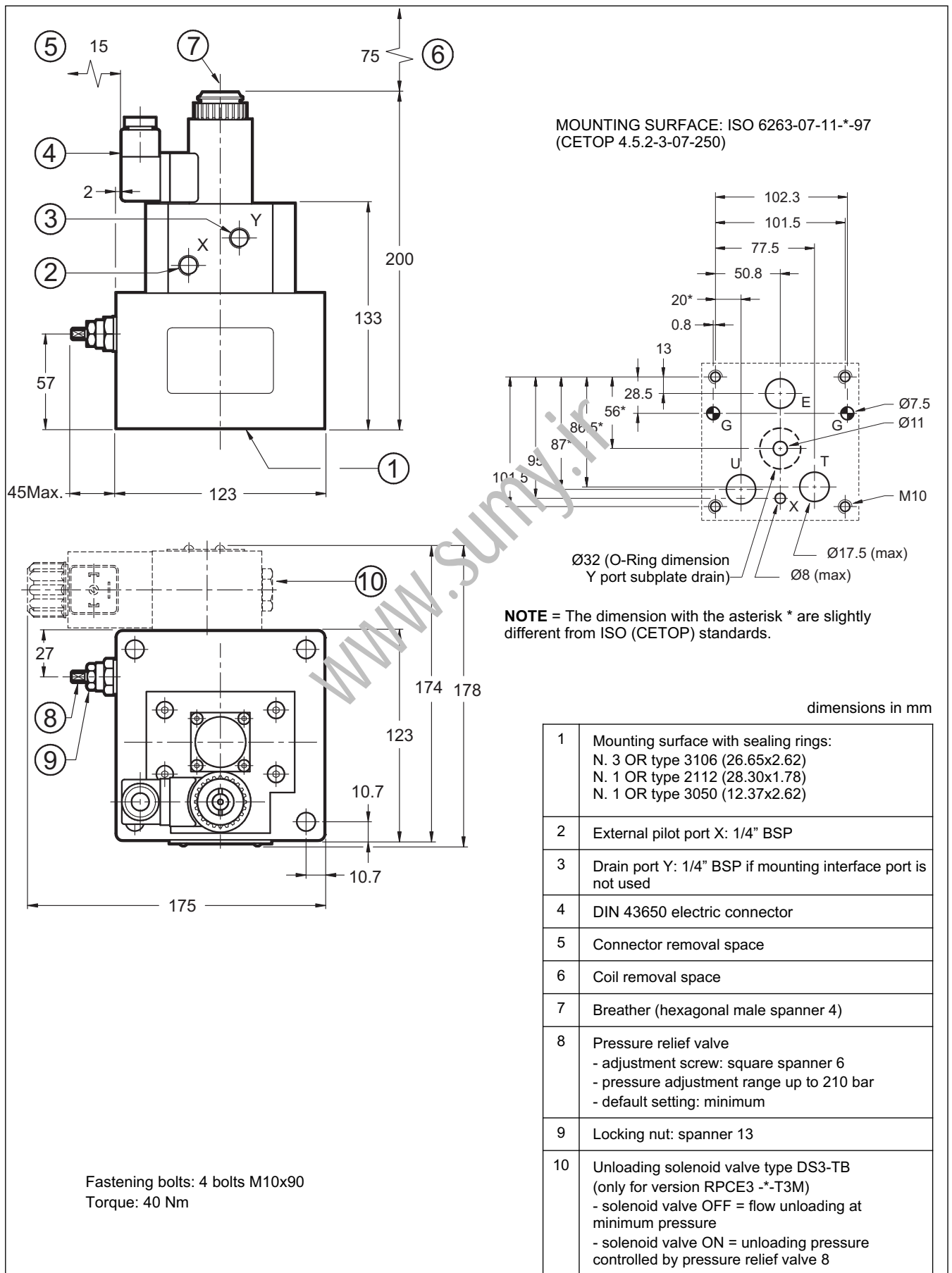

10 - OVERALL AND MOUNTING DIMENSIONS TWO-WAY VALVE RPCE3

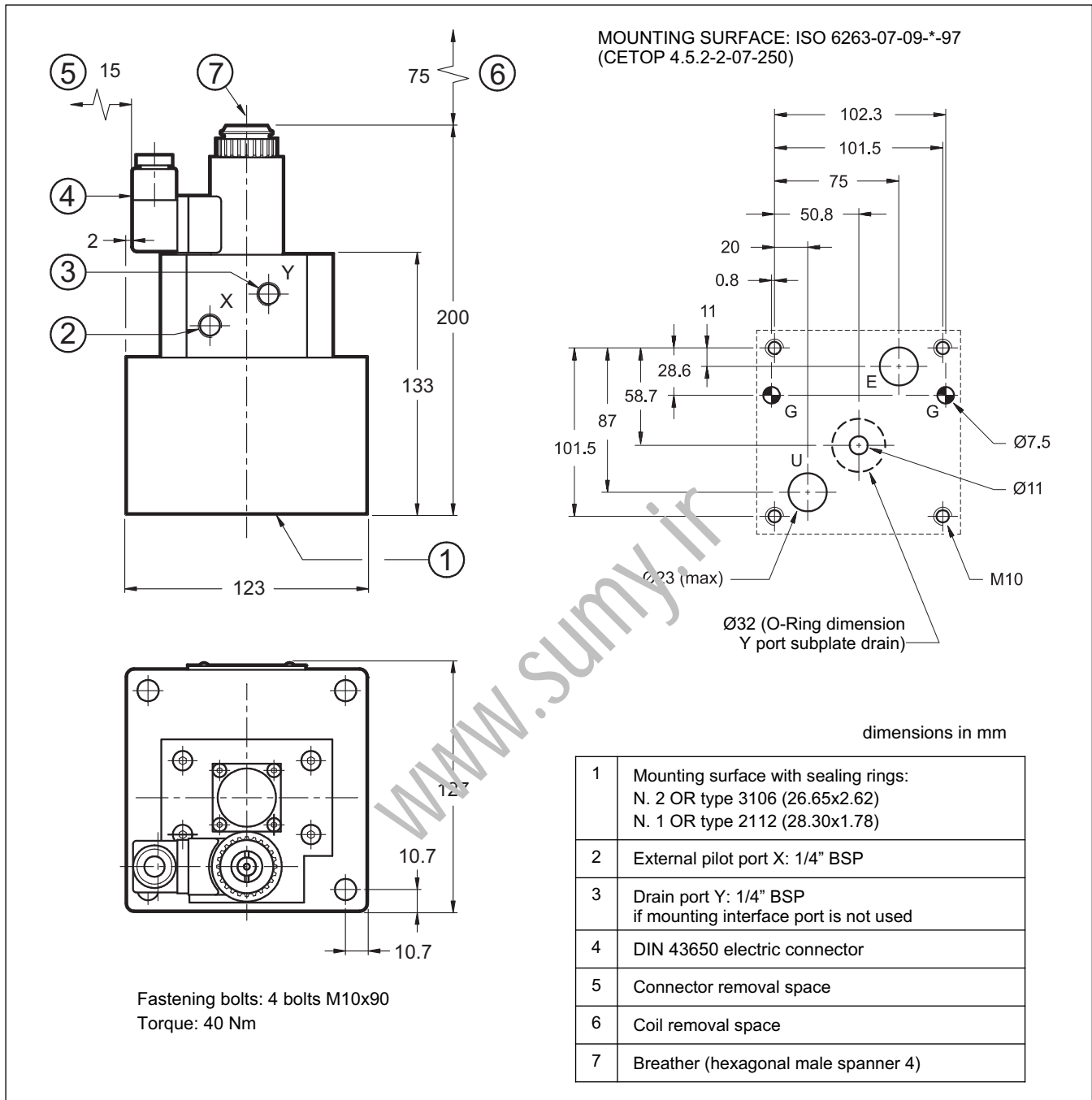

13 - SUBPLATES (see catalogue 51 000)

The valve must have the Y drain with external pipe when using the subplates listed below.

	RPCE3-* two way version	RPCE3--T3 three way version
Type	PMRPC3-AI6G rear ports	PMRPCQ3-AI6G rear ports
E, U, T ports threading	1" BSP	1" BSP
X port threading	-	1/4" BSP