

# DSE3F

## DIRECTIONAL VALVE WITH PROPORTIONAL CONTROL AND ELECTRICAL FEEDBACK

### SERIES 11

**SUBPLATE MOUNTING**  
**ISO 4401-03 (CETOP 03)**

**p** max 350 bar  
**Q** max 40 l/min

#### MOUNTING SURFACE

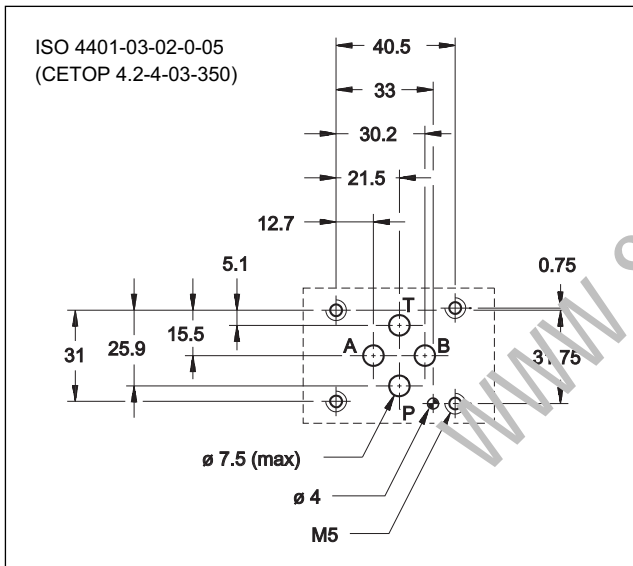

#### OPERATING PRINCIPLE

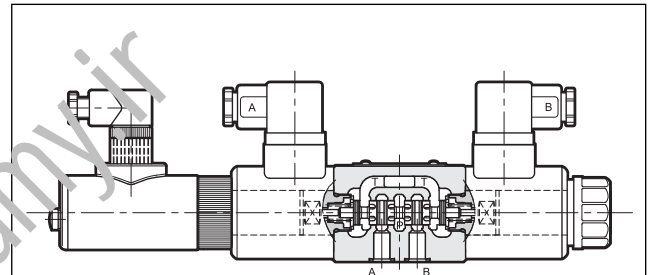

The DSE3F is a direct operated directional valve with proportional control, electrical feedback and mounting interface in compliance with ISO 4401 (CETOP RP 121H) standards.

- It is normally used to control position and the speed of hydraulic actuators.
- The valve opening and hence flow rate can be modulated continuously in proportion to the reference signal.
- The valve must be controlled directly by the UEIK-\*RSD digital card (see par.9), that maximize the valve performances: the input signal and the signal from the valve are compared to obtain an accurate positioning and a reduces hysteresis.

**PERFORMANCES** (Obtained with mineral oil with viscosity of 36 cSt at 50°C and with digital integrated electronic)

Max operating pressure: - P - A - B ports - T port	bar	350 210
Nominal flow with $\Delta p$ 10 bar P-T	l/min	8 - 16 - 26
Response times	see paragraph 6	
Hysteresis	% of $Q_{max}$	< 1,5 %
Repeatability	% of $Q_{max}$	< 1 %
Electrical characteristics, IP	see paragraph 5	
Valve reproducibility	< 5%	
Ambient temperature range	°C	-20 / +60
Fluid temperature range	°C	-20 / +80
Fluid viscosity range	cSt	10 ÷ 400
Fluid contamination degree	according to ISO 4406:1999 class 18/16/13	
Recommended viscosity	cSt	25
Mass: single solenoid valve double solenoid valve	kg	1,9 2,3

#### HYDRAULIC SYMBOLS (typical)

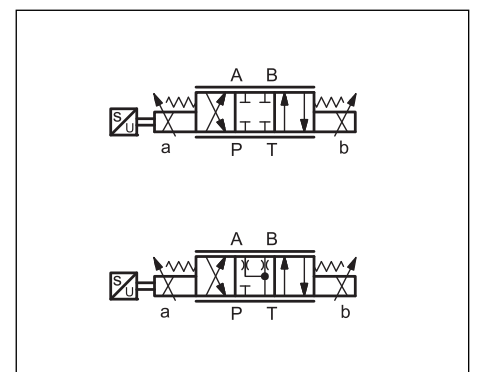

## 1 - IDENTIFICATION CODE

<b>D</b>	<b>S</b>	<b>E</b>	<b>3</b>	<b>F</b>	<b>-</b>					<b>/ 11</b>	<b>-</b>	<b>D12</b>	<b>K1</b>
----------	----------	----------	----------	----------	----------	--	--	--	--	-------------	----------	------------	-----------

Direct operated directional control valve

Electric proportional control

Size ISO 4401-03 (CETOP 03)

Position feedback

Spool type:  
**C** = closed centres  
**A** = open centres

Nominal flow rate:  
**08** = 8 l/min  
**16** = 16 l/min  
**26** = 26 l/min

Solenoid position (omit for configuration with two solenoids):  
**SA** = 1 solenoid on side A

Coil electrical connection:  
 plug for connector type  
 DIN 43650 (**standard**)

Nominal solenoid voltage 12 VDC

Seals:  
**N** = NBR seals for mineral oil (**standard**)  
**V** = FPM seals for special fluids

Series No. (the overall and mounting dimensions remain unchanged from 10 to 19)

## 2 - CONFIGURATIONS

Valve configuration depends on the combination of the following elements:  
 number of proportional solenoids, spool type, rated flow

Configuration 2 solenoids :  
 3 positions with spring centering

Configuration 1 solenoid on side A "SA":  
 2 positions (central + external) with spring centering

*	Controlled flow with $\Delta p_{10}$ bar P-T
<b>08</b>	8 l/min
<b>16</b>	16 l/min
<b>26</b>	26 l/min

### 3 - CHARACTERISTIC CURVES (obtained with mineral oil with viscosity of 36 cSt at 50°C and with digital integrated electronics)

Typical flow rate curves at constant  $\Delta p$  related to the reference signal and measured for the available spools. The  $\Delta p$  values are measured between P and T valve ports.

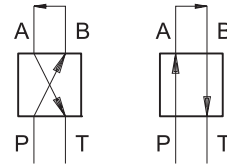

#### SPOOL C08

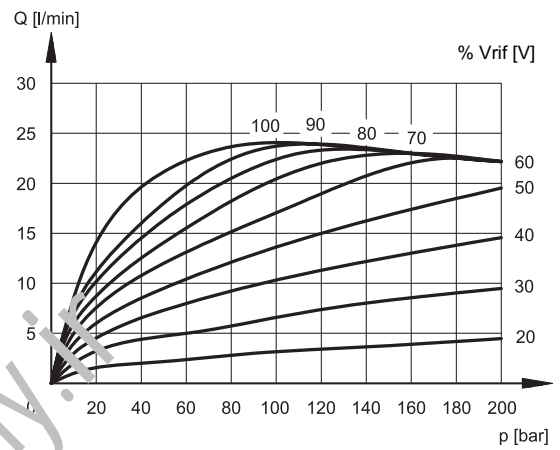
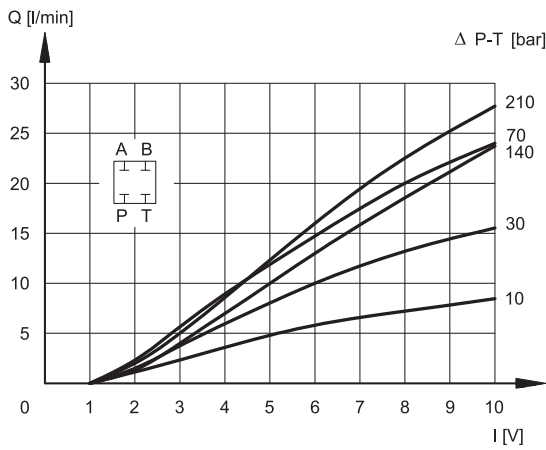

#### SPOOL C1

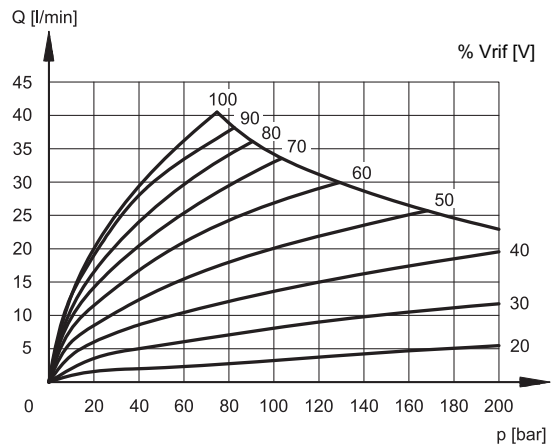
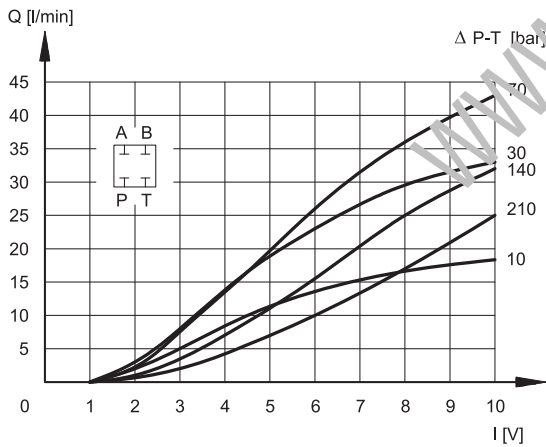

#### SPOOL C26

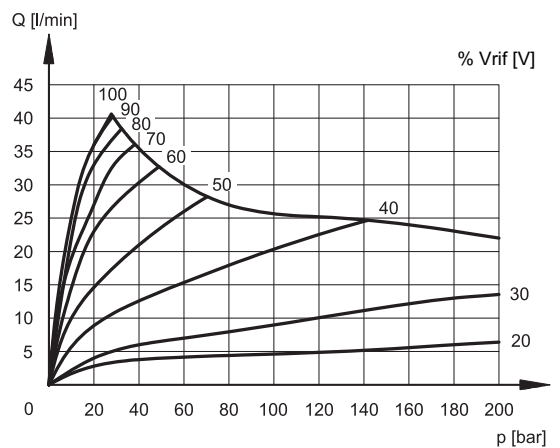
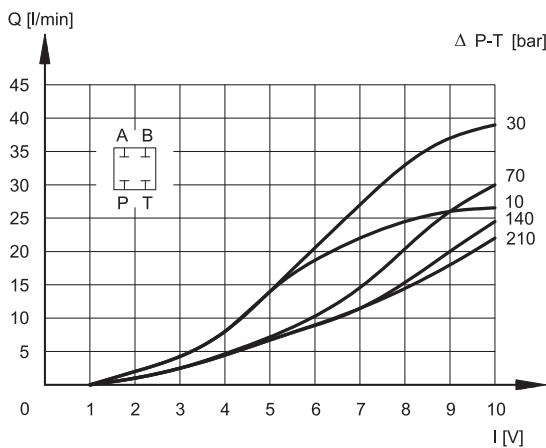



### SPOOL A08

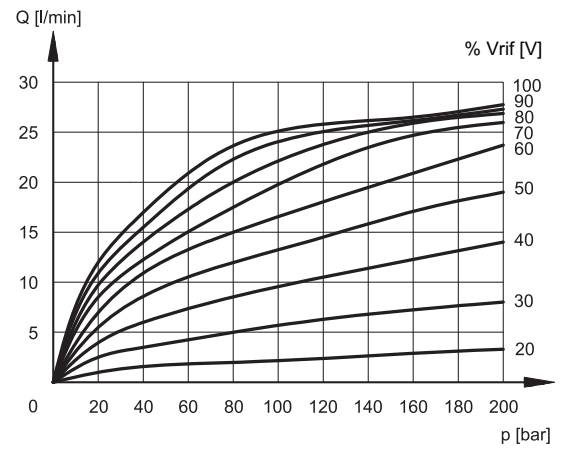
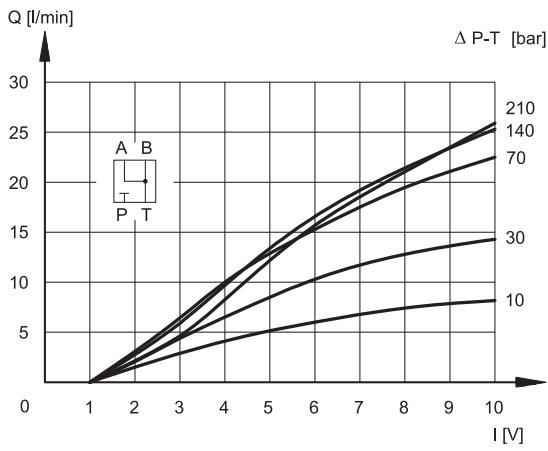

### SPOOL A16

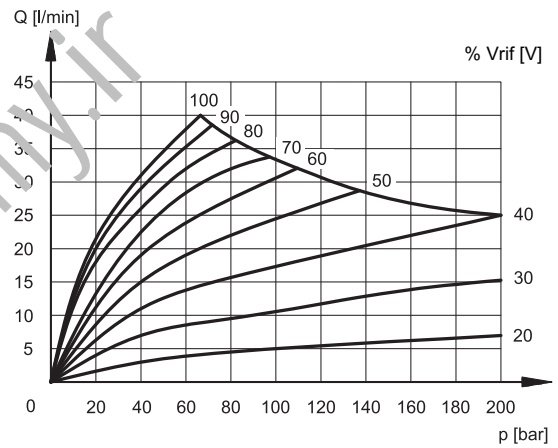
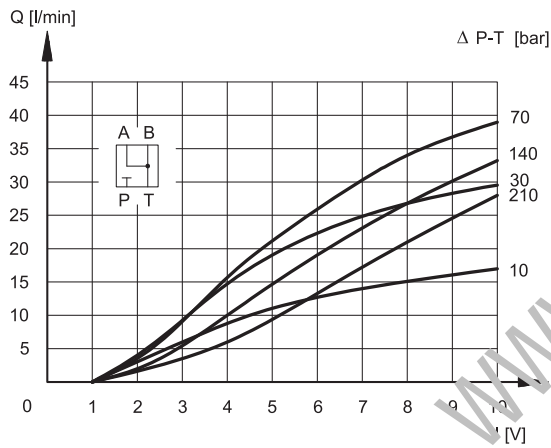

### SPOOL A26

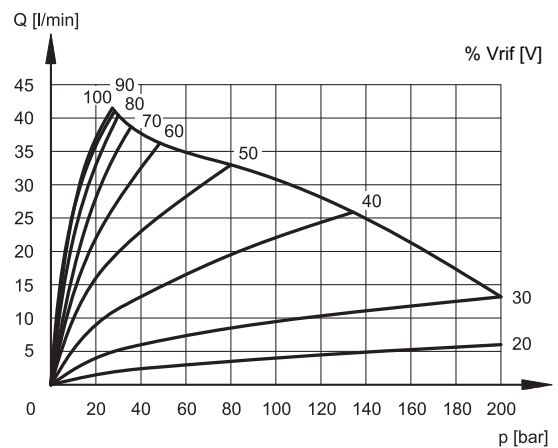
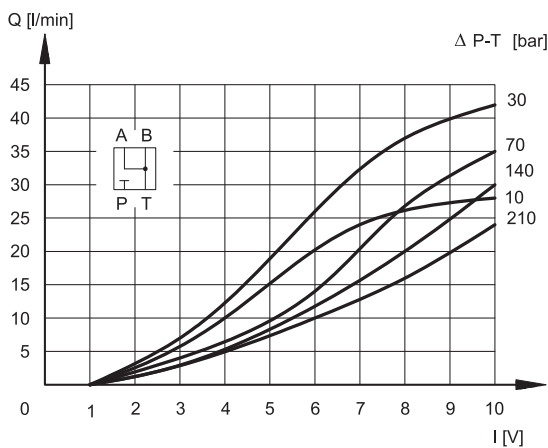

## 4 - HYDRAULIC FLUIDS

Use mineral oil-based hydraulic fluids HL or HM type, according to ISO 6743-4. For these fluids, use NBR seals (code N). For fluids HFDR type (phosphate esters) use FPM seals (code V). For the use of other kinds of fluid such as HFA, HFB, HFC, please consult our technical department.

Using fluids at temperatures higher than 80 °C causes a faster degradation of the fluid and of the seals characteristics.

The fluid must be preserved in its physical and chemical characteristics.

## 5 - ELECTRICAL CHARACTERISTICS

### 5.1 - Proportional solenoid

The proportional solenoid comprises two parts: tube and coil.

The tube, screwed to the valve body, contains the armature which is designed to reduce friction to a minimum thereby reducing hysteresis.

The coil is mounted on the tube and secured by means of a lock nut and can be rotated through 360° depending on installation clearances.

<b>NOMINAL VOLTAGE</b>	V DC	<b>12</b>
<b>RESISTANCE (at 20°C)</b>	Ω	3.66
<b>MAXIMUM CURRENT</b>	A	1.88
<b>DUTY CYCLE</b>		100%
<b>ELECTROMAGNETIC COMPATIBILITY (EMC)</b>	According to 2004/108/CE	
<b>CLASS OF PROTECTION:</b> Atmospheric agents (CEI EN 60529)	IP 65	

### 5.2 - Positional transducer

The DSE3F valve mounts an LVDT type positional transducer with amplified signal to enable precise control of the restrictor and the set flow rate, thus improving repeatability and hysteresis characteristics.

The transducer is fitted coaxially on the proportional solenoid and the connector features 360° positioning.

We recommend to use a screened cable to avoid interferences. Technical specifications and connections are indicated here below.

**The transducer is protected against polarity inversion on the power line.**

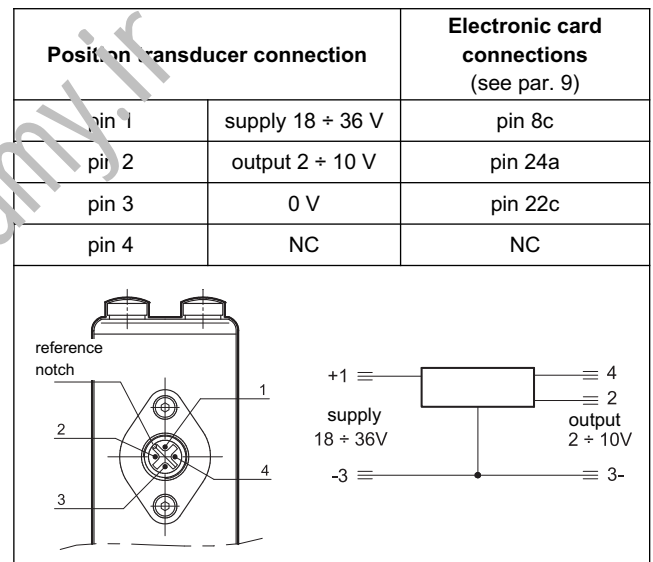

## 6 - STEP RESPONSE (measured with mineral oil with viscosity of 36 cSt at 50°C with electronic control unit)

Step response is the time taken for the valve to reach 90% of the set pressure value following a step change of reference signal.

The table illustrates typical response times with the C13 spool and with  $\Delta p = 30$  bar P-T.

REFERENCE SIGNAL STEP	0 → 100%	100 → 0%
Step response [ms]	30	25

## 7 - INSTALLATION

DSE3F valves can be installed in any position without impairing correct operation.

Ensure that there is no air in the hydraulic circuit.

Valves are fixed by means of screws or tie rods on a flat surface with planarity and roughness equal to or better than those indicated in the relative symbols. If minimum values are not observed fluid can easily leak between the valve and mounting surface.

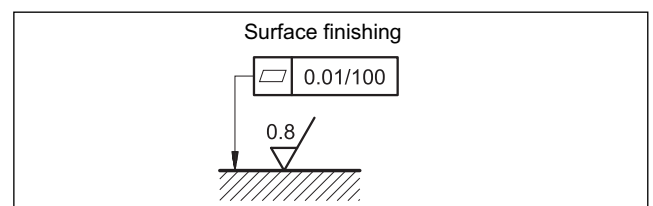

## 9 - OVERALL AND MOUNTING DIMENSIONS

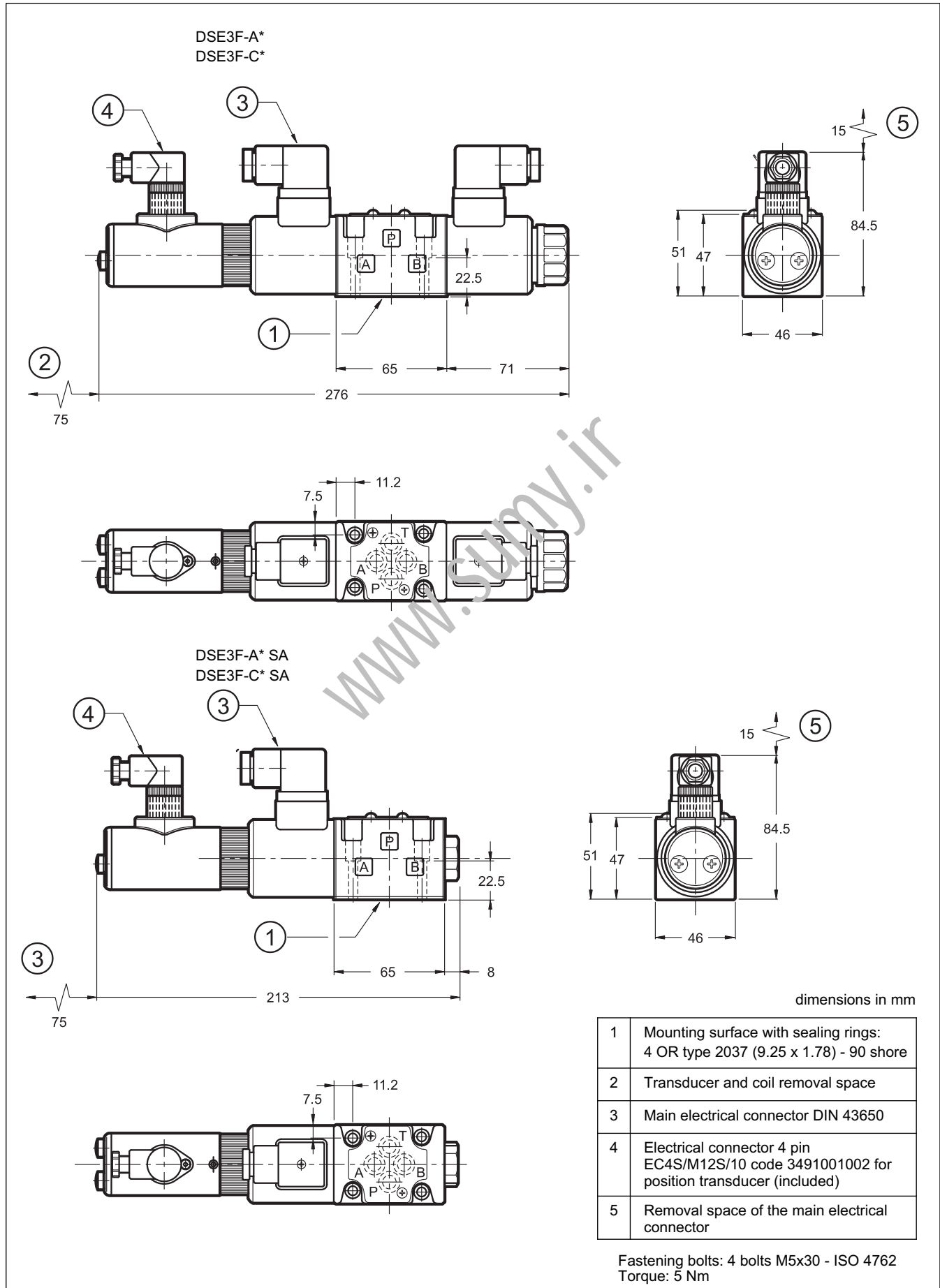



## 9 - ELECTRONIC CONTROL UNITS

<b>UEIK-21RSD</b>	for two solenoids valves 12V DC	Eurocard format	see cat. 89 335
<b>UEIK-11RSD</b>	for single solenoid valve 12V DC	Eurocard format	see cat. 89 315

A card holder, PSC-32D/20 is available, to be ordered separately with code 3899000001.

## 10 - SUBPLATES (see catalogue 51 000)

PMMD-AI3G rear ports
PMMD-AL3G side ports
Ports dimensions: P, T, A, B: 3/8" BSP

www.sumy.ir