



RLM3

ELECTRIC FAST / SLOW SPEED SELECTION VALVE SERIES 10

MODULAR VERSION ISO 4401-03 (CETOP 03)

p max 250 bar
Q max (see table of performances)

MOUNTING SURFACE

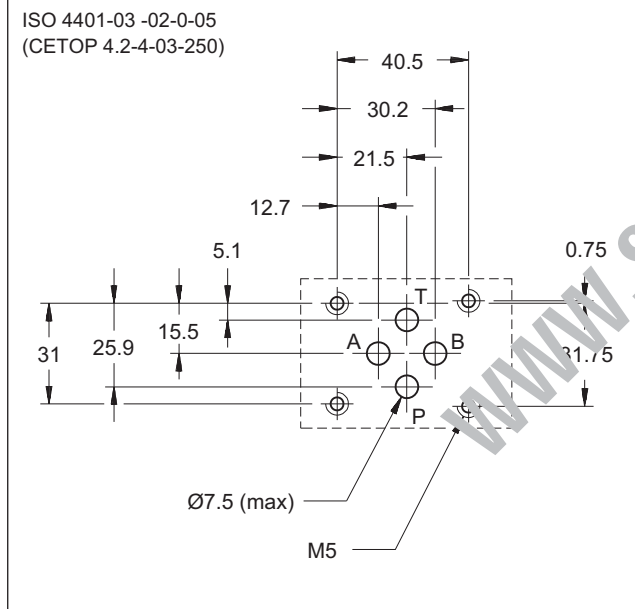

OPERATING PRINCIPLE

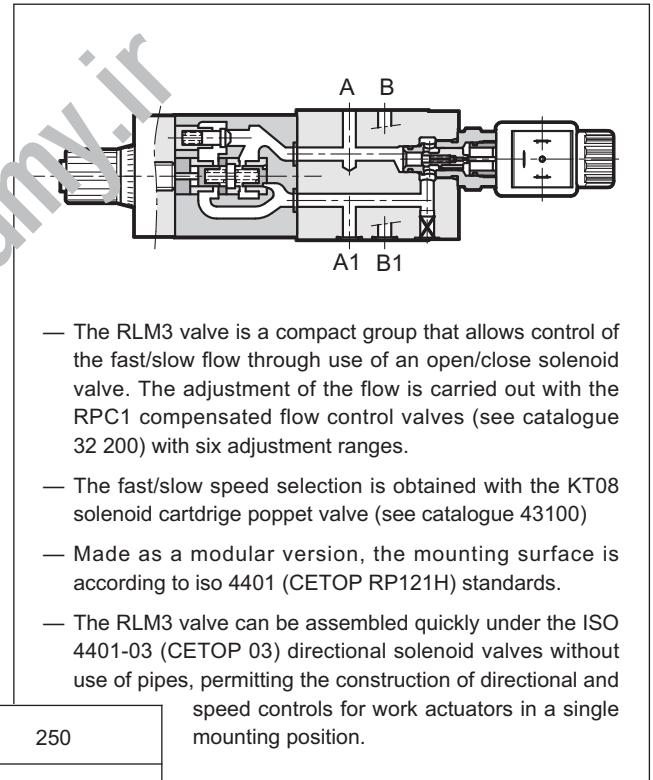

PERFORMANCES (measured with mineral oil of viscosity 36cSt at 50°C)

Maximum operating pressure	bar	250
Maximum flow rate in controlled lines Maximum flow rate in the free lines	l/min	1 - 4 - 10 - 16 - 22 - 30 65
Minimum controlled flow rate	l/min	0,025
Ambient temperature range	°C	-20 / +50
Fluid temperature range	°C	-20 / +80
Fluid viscosity range	cSt	10 ÷ 400
Fluid contamination degree	According to ISO 4406:1999 class 20/18/15	
Recommended viscosity	cSt	25
Mass	kg	3,1

CONFIGURATIONS

(see Hydraulic symbols)

- Configuration "A": meter-out control from the actuator on chamber A.
- Configuration "T": control on discharge T of the directional solenoid valve for speed control in both directions of movement.

1 - IDENTIFICATION CODE

R	L	M	3	-		/	10	-		/	
----------	----------	----------	----------	----------	--	----------	-----------	----------	--	----------	--

Electric fast/ slow speed selection valve

Modular version

Size ISO 4401-03 (CETOP 03)

Adjustments:
A = adjustment on chamber A of the actuator;
T = adjustment on discharge T of the directional solenoid valve

A = normally open solenoid valve
C = normally closed solenoid valve

Flow adjustment range:
01 = 1 l/min **16** = 16 l/min
04 = 4 l/min **22** = 22 l/min
10 = 10 l/min **30** = 30 l/min

Series No. (the overall and mounting dimensions remain unchanged from 10 to 19)

See **NOTE 2**

Coil electrical connection (see paragraph 8)

K1 = plug for connector type DIN 43650 (**standard**)
K2 = plug for connector type AMP JUNIOR
K4 = outgoing cables
K7 = plug for connector type DEUTSCH DT04-2P male
K8 = plug for connector type AMP SUPER SEAL

Coil type:
D12 = 12 V } direct current (**standard**)
D24 = 24 V }
R110 = 110 V } rectified current
R230 = 230 V }
D00 = valve without coil (see **NOTE 1**)

Seals:
N = NBR for mineral oils
V = viton for special fluids

NOTE 1: The coil locking ring and the relevant seals are included in the supply.
NOTE 2: The manual override **CM** is available as an option (see paragraph 8).

N.B. : For further informations about the flow control valve see catalogue 32 200; For further informations about the cartridge poppet valve see catalogue 43 100.

NOTE: The solenoid valves are never supplied with connector. Connectors must be ordered separately. To find out the type of connector to be ordered, please see catalogue 49 000.

1.1 - Coil identification code

C14L3	-			/	10
--------------	----------	--	--	----------	-----------

Power supply

D12 = 12 V } direct current
D24 = 24 V } (**standard**)
R110 = 110 V } rectified
R230 = 230 V } current

Series no.: (the overall and mounting dimensions remain unchanged from 10 to 19)

Coil electrical connection (see paragraph 10)

K1 = plug for connector type DIN 43650 (**standard**)
K2 = plug for connector type AMP JUNIOR
K4 = outgoing cables
K7 = plug for connector type DEUTSCH DT04-2P male
K8 = plug for connector type AMP SUPER SEAL

3 - HYDRAULIC FLUIDS

Use mineral oil-based hydraulic fluids HL or HM type, according to ISO 6743-4. For these fluids, use NBR seals (code N). For fluids HFDR type (phosphate esters) use FPM seals (code V). For the use of other kinds of fluid such as HFA, HFB, HFC, please consult our technical department. Using fluids at temperatures higher than 80 °C causes a faster degradation of the fluid and of the seals characteristics. The fluid must be preserved in its physical and chemical characteristics.

3 - HYDRAULIC SYMBOLS

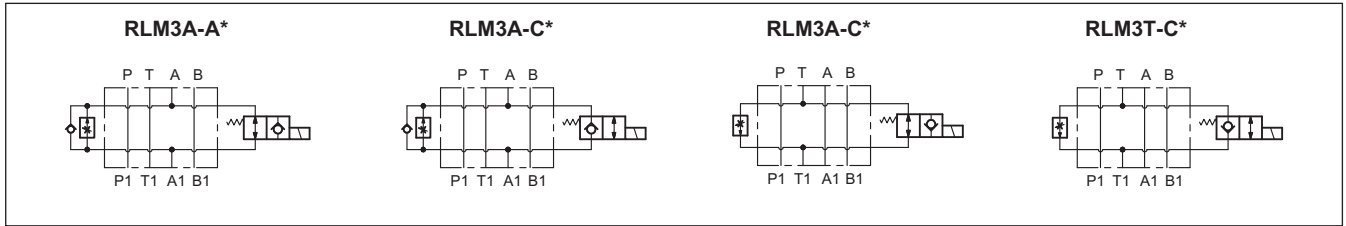

4 - PRESSURE DROPS Δp -Q

(obtained with viscosity of 36 cSt at 50 °C)

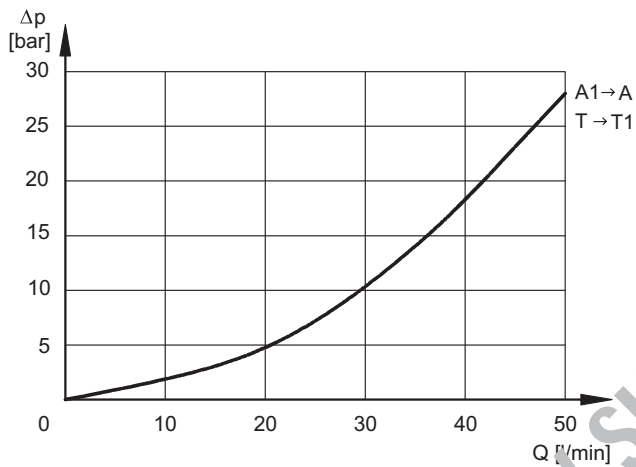

The values in graphs refer to the fast flow through the solenoid valve and are equal for A (normally open) and C (normally closed) versions.

5 - SWITCHING TIME

The values are obtained according to the ISO 6403 standard, with mineral oil at 50°C, with viscosity of 36 cSt.

TIMES [ms]	ENERGIZING	DE-ENERGIZING
RLM3*-A*	85	60
RLM3*-C*	60	85

6 - OPERATING LIMITS

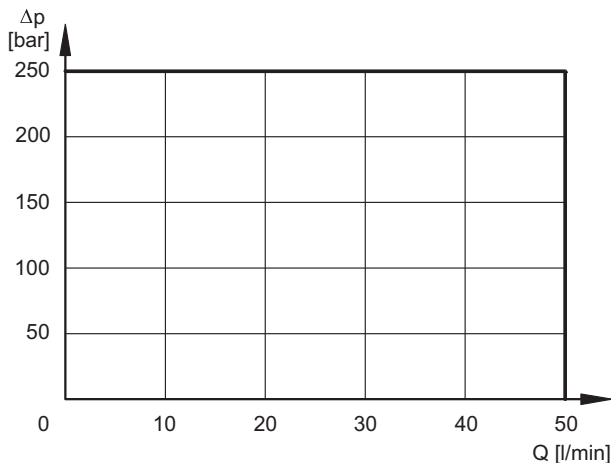

The curves define the flow rate operating fields according to the valve pressure of the different versions.

The values have been obtained according to ISO 6403 norm with solenoids at rated temperature and supplied with voltage equal to 90% of the nominal voltage.

The value have been obtained with mineral oil, viscosity 36 cSt, temperature 50 °C and filtration according to ISO 4406:1999 class 18/16/13.

5 - ELECTRICAL FEATURES

5.1 Solenoids

These are essentially made up of two parts: tube and coil. The tube is threaded onto the valve body and includes the armature that moves immersed in oil, without wear. The inner part, in contact with the oil in the return line, ensures heat dissipation. The coil is fastened to the tube by a threaded nut, and can be rotated according to the available space.

The interchangeability of coils of different voltages both D or R type is possible without removing the tube.

Protection according CEI EN 60529 - atmospheric agents

Connector	IP 65	IP 67	IP 69 K
K1 DIN 43650	x		
K2 AMP JUNIOR	x	x	
K4 outgoing cables	x	x	
K7 DEUTSCH DT04 male	x	x	x
K8 AMP SUPER SEAL	x	x	x

NOTE: The protection degree is guaranteed only with the connector correctly connected and installed.

VOLTAGE SUPPLY FLUCTUATION	± 10% Vnom
MAX SWITCH ON FREQUENCY	10.000 ins/hr
DUTY CYCLE	100%
ELECTROMAGNETIC COMPATIBILITY (EMC) (NOTE 1)	In compliance with 2004/108/CE
LOW VOLTAGE	In compliance with 2006/95/CE
CLASS OF PROTECTION: Atmospheric agents (CEI EN 60529) Coil insulation (VDE 0580) Impregnation:	IP 65 (NOTE 2) class H class H

5.2 Current and absorbed power

In the table are shown current and power consumption values relevant to the different coil types. "R" coil must be used when the valve is fed with AC power supply subsequently rectified by means of rectifier bridge, externally or incorporated in the "D" type connector (see cat. 49 000).

	Resistance at 20°C [Ω] (±1%)	Absorbed current [A] (±5%)	Absorbed power (±5%)		Coil code				
			[W]	[VA]	K1	K2	K4	K7	K8
C14L3-D12*	5,4	2,2	26,5		1902740	1902750	1902770	1902980	1903020
C14L3-D24*	20,7	1,16	27,8		1902741	1902751	1902771	1902981	1903021
C14L3-R110*	363	0,25		27,2	1902742				
C14L3-R230*	1640	0,11		26,4	1902743				

8 - MANUAL OVERRIDE

CM for NO version (pushing type)

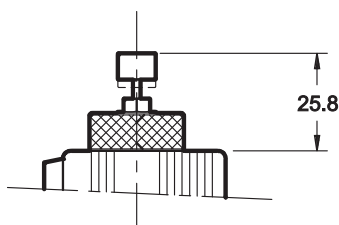

CM for NC version (screw type)

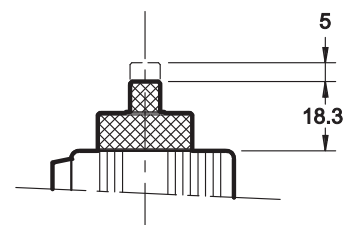

9 - OVERALL AND MOUNTING DIMENSIONS

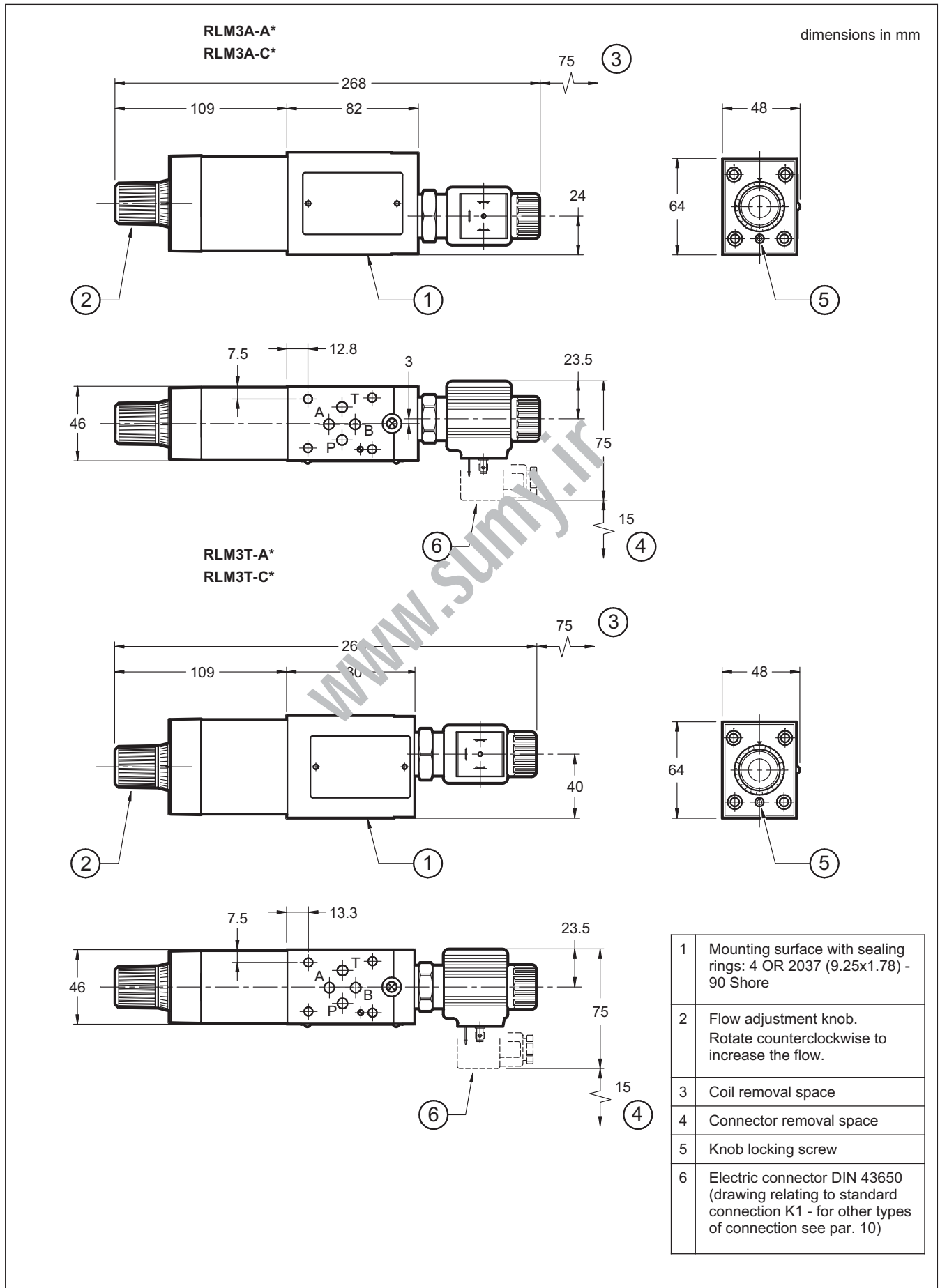

10 - ELECTRIC CONNECTIONS

connection for DIN 43650 connector
code **K1 (standard)**

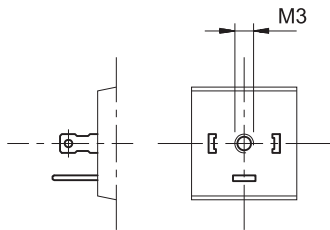

connection for AMP JUNIOR connector
code **K2**

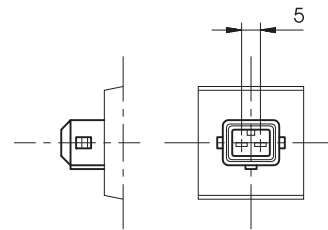

outgoing cables connection
code **K4**

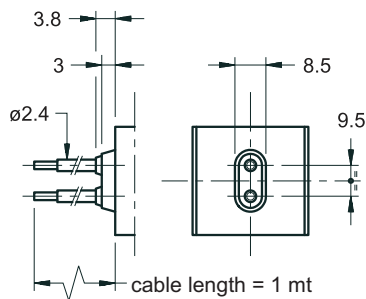

connection for DEUTSCH DT04-2P male connector
code **K7**

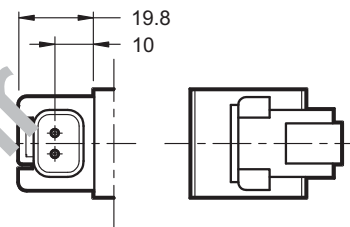

connection for AMP SUPER SEAL connector (two contacts)
code **K8**

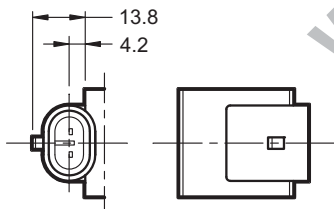

11 - ELECTRIC CONNECTORS

The solenoid valves are supplied without connectors. For coils with standard electrical connections K1 type (DIN 43650) the connectors can be ordered separately. For the identification of the connector type to be ordered please see catalog 49 000. For K2, K7 and K8 connection type the relative connectors are not available.